

LEISTER®

English

COMET 700



COMET 500

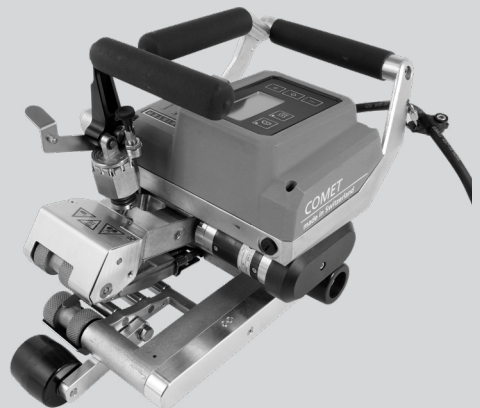

Leister Technologies AG
Galileo-Strasse 10
6056 Kaegiswil/Switzerland
Tel. +41 41 662 74 74
Fax +41 41 662 74 16
www.leister.com
sales@leister.com

Table of contents

1. Application COMET 700/500	4
1.1. Important safety instructions	4
1.2. Intended use	5
1.3. Non-intended use	5
2. Technical data COMET 700/500	6
3. Transport COMET 700/500	7
4. Your COMET 700/500	8
4.1. Type plate and identification	8
4.2. Scope of delivery	8
4.3. Optional accessories	8
4.4. Overview of device parts	9
4.5. Park position	10
4.6. Power supply interruption	10
5. Settings on COMET 700/500	11
5.1. Checking the position of the hot wedge	11
5.2. Contacting system setup	12
6. Quick Guide COMET 700/500	13
6.1. Switch on COMET 700/500 (upper line)	13
6.2. Switch off COMET 700/500 (lower line)	13
7. Control panel of the COMET 700	14
7.1. Control panel overview	14
7.2. Function keys	14
7.3. Display of the status LED	15
7.4. Display symbols of the status display	16
7.5. Display symbols of the function display	16
7.6. Display symbols of the working display	17
8. COMET 700 control panel setup menu	18
8.1. Menu navigation overview	18
8.2. Setting up, saving, and selecting recipes (Save recipes)	19
8.3. Entry of recipe names	21
8.4. Standby Mode	22
8.5. Advanced Mode	22
8.6. Duty Info	23
8.7. General Info	23
8.8. Warnings	23
8.9. Machine Setup	23
8.10. Application Mode	24
8.11. Set Values	24
8.12. Welding data recording and WLAN settings WLAN settings	25
8.13. Reset (Reset to defaults)	25
8.14. Day distance display	25
8.15. Key lock	26

9. Commissioning COMET 700	27
9.1. Work environment and safety	27
9.2. Preparation for welding	27
9.3. Welding process	29
10. Warnings and error messages COMET 700	31
11. COMET 500 control panel	32
11.1. Control panel overview	32
11.2. Status LED display	32
11.3. Display symbols	33
11.4. Setting the unit system	33
11.5. Key lock	33
12. Commissioning COMET 500	34
12.1. Work environment and safety	34
12.2. Preparation for welding	35
12.3. Welding process	37
13. COMET 500 errors	38
14. Frequently asked questions, causes, and measures COMET 700/500	38
15. Assembly of accessories COMET 700/500	39
15.1. Replacement of the drive/pressure rollers	39
15.2. Assembling the field kit	40
15.3. Assembling the guide bar	41
15.4. Assembling the drive roller extension	41
16. Maintenance COMET 700/500	42
17. Disposal COMET 700/500	43
18. Declaration of conformity COMET 700/500	43

Operating Manual (Translation of the Original User Manual)

Congratulations on purchasing your COMET 700 or 500.

You have chosen a first-class hot-wedge welding machine. It was developed and produced in accordance with the latest technology in the plastics-processing industry. It has also been manufactured using high-quality materials.



We recommend that you always keep the instruction manual with the device.

COMET 700/500 Hot wedge welding machine



You can find more information on the COMET 700/500 and the myLeister app at www.leister.com

1. Application COMET 700/500

1.1. Important safety instructions

Read through the operating instructions before commissioning for the first time.

In addition to the safety instructions contained in the individual sections of this instruction manual, the following regulations must always be observed.

Warning



There is a danger to life

from electric shock due to electrical voltage. The welding machine must therefore only be connected to sockets and extension cables with a protective earth conductor. Protect the welding machine from moisture and wet conditions. Prior to commissioning, check the power cord, the plug, and the extension cable for electrical and mechanical damage. The welding machine may only be opened by instructed, qualified personnel.



Risk of fire and explosion

The welding machine can become an ignition source for fire and explosion. It must therefore not be used near explosive gases or flammable materials. To avoid burning of the material to be welded, please read the material safety data sheet from the material manufacturer. The welding machine must only be used in the open or in a well-ventilated area.



Risk of burns

Do not touch hot wedge and surrounding parts when hot. Only touch the device at the handles and operating units. Always allow the device to cool down.

Caution



The local supply voltage must match the **nominal voltage** specified on the device. If the line voltage fails, switch off the main switch and place the welding machine in the park position. EN 61000-3-11; $Z_{\text{max}} = 0.324\Omega + j 0.202\Omega$. Consult electricity supply company if necessary.



If the device is being used on construction sites, a **fault current circuit breaker** must be used to protect site personnel from electrical shock **due to dampness and moisture**.



Do not touch moving parts

There is a risk of inadvertently becoming caught and being pulled in. Do not wear loose articles of clothing such as scarves or shawls. Tie up long hair or protect it by wearing headgear.



The device **may only be operated under supervision** as waste heat can reach flammable materials. The device should also only be operated by **trained specialists** or under their supervision. Children are not permitted to operate the device.



When welding, be aware of device hazards in the surrounding area, e.g., risk of tripping, risk of slipping, strong sunlight, unattended equipment, etc.

1.2. Intended use

The COMET 700/500 is intended for overlap welding of thermoplastic films and sealing sheets. Only use original Leister spare parts and accessories; otherwise, any warranty and/or guarantee claims will be invalidated.

Welding geometry

- The maximum overlap width of the lower and upper membranes is 125 mm.
- Welding seam widths 45 mm or 50 mm (depending on design).
- Welding seam with/without test channel (depending on version).

Material types and thicknesses

Material-specific properties can influence the welding capability.









Material	Material thickness reference value	Hot Wedge
PE-HD, PP	0.5 mm – 2.5 mm/ 20 mil – 100 mil	Copper
PE-LD, TPO, FPO	0.5 mm – 3.0 mm/ 20 mil – 120 mil	Copper
CSPE	0.5 mm – 2.5 mm/ 20 mil – 100 mil	Steel
PVC-P	0.5 mm – 3.0 mm/ 20 mil – 120 mil	Steel

Additional materials upon request.

1.3. Non-intended use

Any other use or any use beyond the type of use described is deemed non-intended use. In particular, the welding of unintended materials.

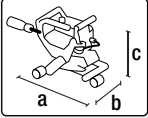
2. Technical data COMET 700/500

			COMET 700 230 V	COMET 700 120 B	COMET 500 230 V
	Voltage	* V~	230	120	230
	Power	W	2300	1700	2300
	Frequency	Hz	50/60		
	Temperature	°C	80 – 460		
		°F	176 – 860		
	Drive	m/min	0.8 – 8.0		
		ft/min	2.6 – 26.2		
	Max. joining force	N	1000		
		lbf	225		
	Noise level LA	L _{PA} (dB)	60.4 (K = 3 dB)		
	Sound power level	L _{WA} (dB)	68.4 (K = 3 dB)		
	Vibration level	a _h (m/s ²)	< 2.5 (K = 1.5 m/s ²)		
	Weight	kg	9.4	9.4	9.2
	(without power cord)	lbs	20.7	20.7	20.3
	Dimensions	a) mm	375 (field kit) or 325 (indoor kit)		
		inches	14.7 (field kit) or 12.7 (indoor kit)		
		b) mm	285 (field kit) or 245 (indoor kit)		
		inches	11.1 (field kit) or 9.6 (indoor kit)		
		c) mm	285 (field kit) or 260 (indoor kit)		
		inches	11.1 (field kit) or 10.2 (indoor kit)		
			 		

* Connection voltage cannot be changed
We reserve the right to make technical changes.

3. Transport COMET 700/500

Use the storage box supplied and the handle attached to the storage box to transport the hot wedge welding machine.



The **hot wedge (15)** must have cooled down to at least 60°C/140°F before transport.



Never store flammable materials (e.g. plastic, wood) in the storage box!



Never use the **handles (2)** and the **clamping lever (4)** on the device or the handles on the storage box for transport with the crane.



Comply with applicable national **regulations regarding the carrying or lifting of loads**.
The total weight of your COMET 700/500 including transport box is up to 14.5 kg (depending on the version).

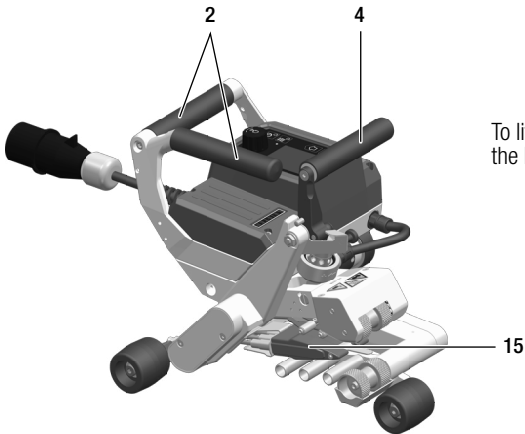

To lift the hot wedge welding machine manually, use the **handles (2)** and the **clamping lever (4)**.

4. Your COMET 700/500

4.1. Type plate and identification

The model and serial number are indicated on your device's **name plate (18)**.

Please transfer this information to your instruction manual. In the event of any inquiries to our representatives or authorized Leister Service Centers, please always refer to this information.

Model:.....

Serial no.:.....

Example of a name plate for COMET 700 and COMET 500

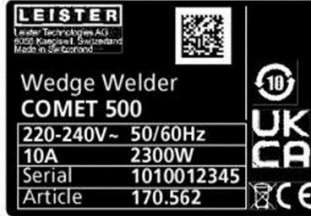

4.2. Scope of delivery

Standard equipment in the storage box:

- 1x COMET 700/500 hot wedge welding machine (according to your specification)
- 1x Quick Guide (glued into case)
- 1x Safety instructions
- 1x Brass brush
- 1x Test Certificate (COMET 700 only)

4.3. Optional accessories

You can find more information on optional accessories at www.leister.com

4.4. Overview of device parts

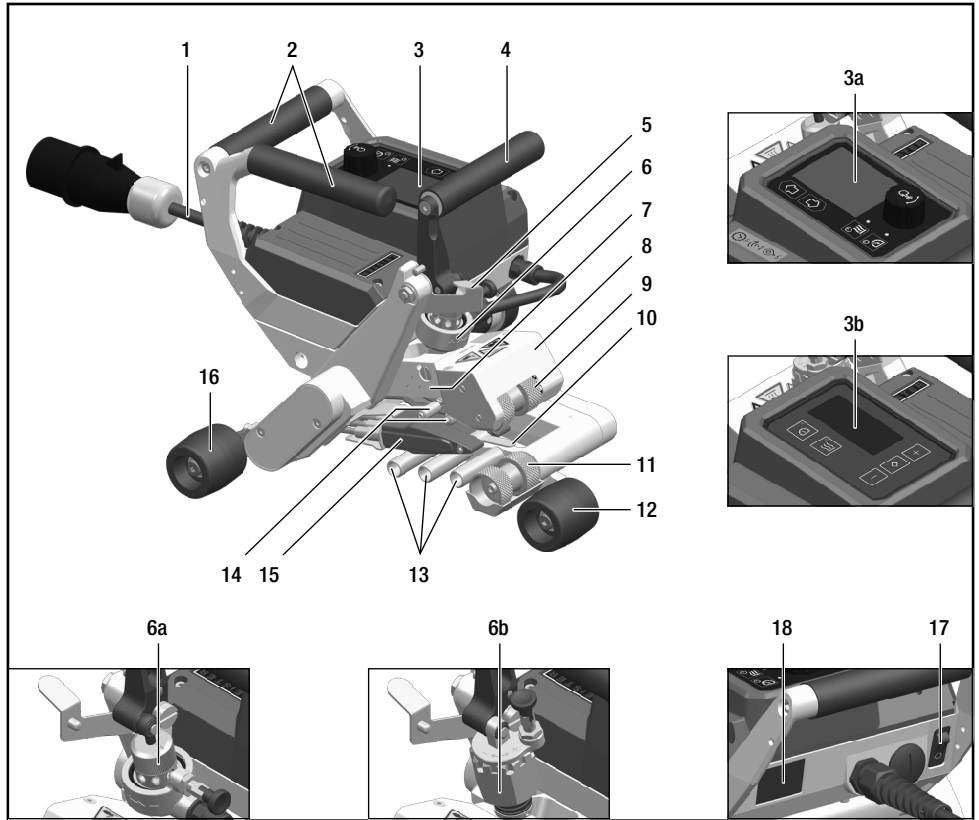

- | | |
|---|--|
| 1. Power cord | 11. drive/pressure roller bottom |
| 2. for handles | 12. roller rear |
| 3. on control panel
(3a COMET 700, 3b COMET 500) | 13. contacting system bottom |
| 4. clamping lever | 14. contacting system top |
| 5. for locking clamping lever | 15. hot wedge |
| 6. for joining force module
(6a COMET 700, 6b COMET 500) | 16. rollers front (according to your device specification) |
| 7. clamping arm | 17. main switch |
| 8. for swing head | 18. name plate (with model number and serial number) |
| 9. for drive/pressure roller, top | |
| 10. Towing tongue (according to your device specification) | |

4.5. Park position

The **clamping lever (4)** must be open during work interruptions and for cooling. The device must be stored in accordance with the figure below and secured against rolling away independently.

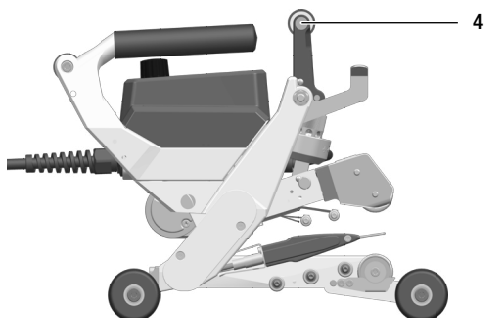

4.6. Power supply interruption



The local supply voltage must match the **nominal voltage** specified on the device. If the line voltage fails, switch off the main switch and place the welding machine in the park position. EN 61000-3-11; $Z_{max} = 0.324\Omega + j 0.202\Omega$. Consult electricity supply company if necessary.

Condition of device prior to power supply interruption	Duration power outage	Condition of device after power supply interruption	
		COMET 700	COMET 500
The drive and heating are switched on	≤ 5 sec	<p>If the BASIC recipe is loaded: The device continues to run without a restart safeguard with the same settings as before the outage.</p> <p>If another recipe is loaded: The device continues to run without protection against restarting with the settings stored in the recipe.</p>	The device continues to run without a restart safeguard with the same settings as before the outage.
	> 5 sec	The device restarts. The start display appears on the display.	
Drive and/or heating are switched off	> 0 sec	The device restarts. The start display appears on the display.	

5. Settings on COMET 700/500

5.1. Checking the position of the hot wedge



Before the hot wedge is aligned with the welding machine, the device must be cooled down and the main switch must be switched off. The power cord must have been disconnected from the power supply.



Risk of crushing and shearing

When operating the clamping lever and clamping arm, there is a risk of injury to the hand. Always hold the hot wedge welding machine by the handles and control units provided.

Check whether the **hot wedge (15)** is aligned centrally with the **drive/pressure roller (11)** (Figure 1). If this is not the case:

- Loosen the three countersunk screws on the cable protection plate (Figure 2) and remove the cable protection plate.
- Loosen the two cylinder screws on the wedge plate slightly (Figure 3). The cylinder screws do not have to be completely loosened
- Align the **hot wedge (15)** so that it is in the middle of the **drive/pressure roller at the bottom (11)**.
- Tighten the two cylinder screws on the wedge plate again (Figure 3).
- Reattach the cable protection plate with the three countersunk screws (Figure 2). Make sure that the cables of the heating cartridges and the temperature probe are not pinched.

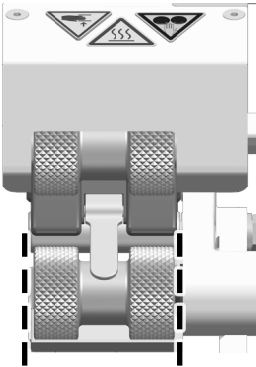

Figure 1

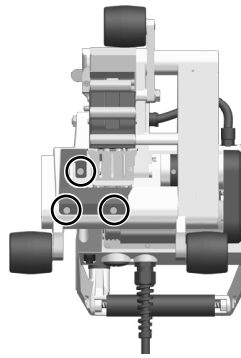

Figure 2

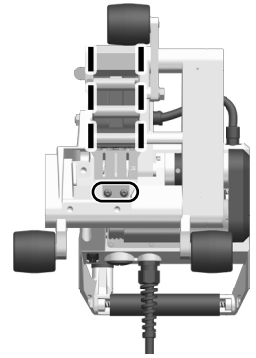

Figure 3

5.2. Contacting system setup

Depending on the hot wedge length and the material to be welded, a different setup of the **lower contacting system (13)** and the upper **contacting system (14)** is necessary in order to improve contacting on the **welding wedge (15)**.

The material to be welded	1. Contact roller	Contact plate short	Contact plate long	Example (60 mm wedge)
PE-HD, PE-LD, PP, TPO, FPO	small	Sheet thickness 1.0 mm	Bend 31 mm, 2 pieces	Figure 4
CSPE	large	Sheet thickness 0.8 mm	Bend 31 mm, 2 pieces	Figure 5
PVC-P	large	Sheet thickness 0.8 mm	Bend 46 mm, 1 piece	Figure 6

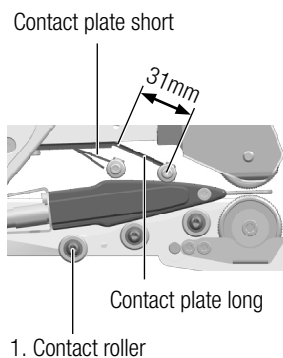

Figure 4

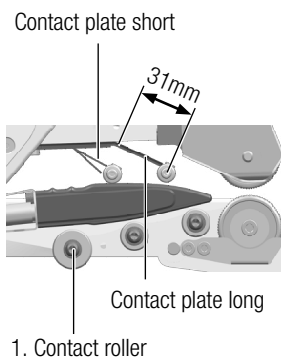

Figure 5

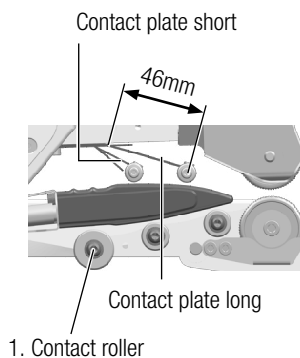



Figure 6





6. Quick Guide COMET 700/500



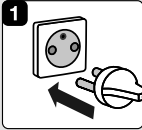

LEISTER **COMET 700/500**
Quick Guide

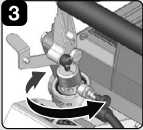
Operating Instructions:
leister.com/DLP-Comet-700

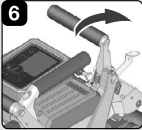
Download
myLeister App
(to use LQS)

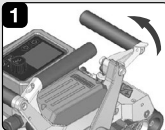

1  **2**  **3**  **4**  **2 sec** **5**  **6** 

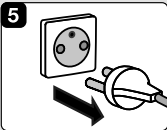
 **1**  **2**  **3**  **2 sec** **4**  **5** 

QG COMET 700/500 / Art. 172.370 / 08.2021

6.1. Switch on COMET 700/500 (upper line)

1. **Connect the power supply cord (1)** to the voltage source
2. Switch on the device at the **main switch (17)**
3. Set the joining force with **the joining force module (6)**
4. Switch on the heating with the *Heating on/off key (24 or 38)* (press the key for 2 seconds); wait until the nominal value of the hot wedge temperature has been reached (approx. 2 to 3 minutes)
5. Switch on the drive with the *Drive on/off key (25 or 37)*
6. Close the **clamping lever (4)**

6.2. Switch off COMET 700/500 (lower line)



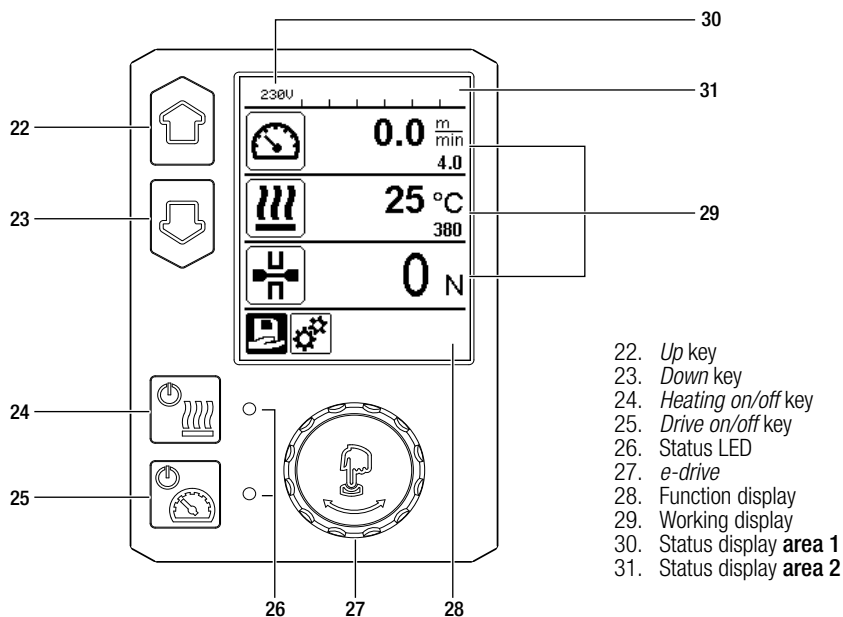

1. **Open clamping lever (4)**
2. Switch off drive with *Drive on/off key (25 or 37)*
3. Switch off heating with *Heating on/off key (24 or 38)* (press key for 2 seconds)
4. Switch off device at **main switch (17)**
5. Disconnect **power cord (1)** from the voltage source and allow the device to cool down

7. COMET 700 control panel

7.1. Control panel overview





7.2. Function keys

Key	Current selection working display	Current selection function display	Current selection Setup Menu
 Up (22) Down (23)	changes the position within the working display	switches from function display to working display.	changes the position within the Setup menu.
 Heating on/off (24)	Switches heating on/off	Switches heating on/off	No function
 Drive on/off (25)	Switches drive on/off	Switches drive on/off	No function
 Press e-drive (27)	Set value is adopted and the selection goes straight back to the function display	Selected function is executed	Selects the selected position
 Rotate e-drive (27)	Sets the desired set-points in 5 °C or 0.1 m/min increments	Changes the position in the function display	<ul style="list-style-type: none"> Changes the position within the setup menu sets the value of the selected position

7.3. Display of the status LED



Heating

The **Status LED (26)** on the *Heating on/off (24)* key displays the respective heating state.

Status LED (26) for the Heating on/off key (24)	Condition	Cause
LED off	Heating is switched off.	
LED flashes green	Heating is switched on, hot wedge temperature outside the tolerance range	
LED lights up green	Heating is switched on, hot wedge temperature within the tolerance range	
If, during operation, a warning message occurs in the Status display area 2 (31) or if there is an error message in the Working display (29) , then this will be displayed as followed:		
LED flashes red	Warning message for the heating	see  Warning and error messages COMET 700 [10]
LED lights up red	Error message for the heating	see  Warning and error messages COMET 700 [10]

Drive

The **Status LED (26)** on the *Drive on/off (25)* displays the drive state.









Status LED (26) for the Drive on/off key (25)	Condition	Cause
LED off	Heating is switched off.	
LED lights up green	Drive is switched on	
If, during operation of the drive, a warning message occurs in the Status display area 2 (31) or if there is an error message in the working display (29) , then this will be displayed as followed:		
LED flashes red	Drive power limit is active	see  Warning and error messages COMET 700 [10]
LED lights up red	The drive has an error	see  Warning and error messages COMET 700 [10]

7.4. Display symbols of the status display

Status display area 1 (30)









Recipe name	Welding parameters currently selected If names consist of more than 6 characters, the first 6 characters are shown first, followed by the remaining characters.
230 V	Current supply voltage at power plug
No. 1	Current file number of the welding data record

Status display area 2 (31)













 Warning present	 Undervoltage	 Overvoltage
 Key lock active	 Heating enabled	 Data recording active
 WLAN connection	 GPS signal available	

7.5. Display symbols of the function display

Select available menus with the *e-drive* (27).

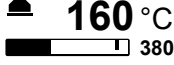
Symbol	Meaning	Symbol	Meaning
	Open recipe		Service menu (can only be accessed by entering the password)
	Settings		Save
	Return to working display		Delete
	Go back one level		Editing
	Resetting		

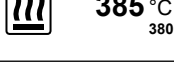
7.6. Display symbols of the working display

Symbol	Meaning
	Drive speed unlocked [m/min or ft/min]
	Drive speed locked [m/min or ft/min]
	Hot-wedge temperature [°C/°F]
	Joining force [N/lbf]
	Information box
	Device in standby mode When the counter has expired, the heating is switched off. See Warning and error messages COMET 700 [8.4]
	An error has occurred. An error code also appears. (The device is no longer ready for operation.) Contact an authorized service center. See Warning and error messages COMET 700 [10]
	Device has a warning see Warning and error messages COMET 700 [10]
	The arrow pointing upward and the progress bar indicate that the setpoint (shown on the progress bar) has not yet been reached (too cold). The flashing value is the actual value. The value next to the progress bar is the nominal value.
	The arrow pointing downward and the progress bar indicate that the setpoint (shown on the progress bar) has not yet been reached (too hot). The flashing value is the actual value. The value next to the progress bar is the nominal value.
	If Set values is activated, both the actual temperature (large font size) and the set temperature (small font size) are displayed. Default setting ex-works. See Actual value display (Set values) [8.11]
	If Set values is disabled, only the actual values are displayed. See Actual value display (Set values) [8.11]

8. COMET 700 control panel setup menu



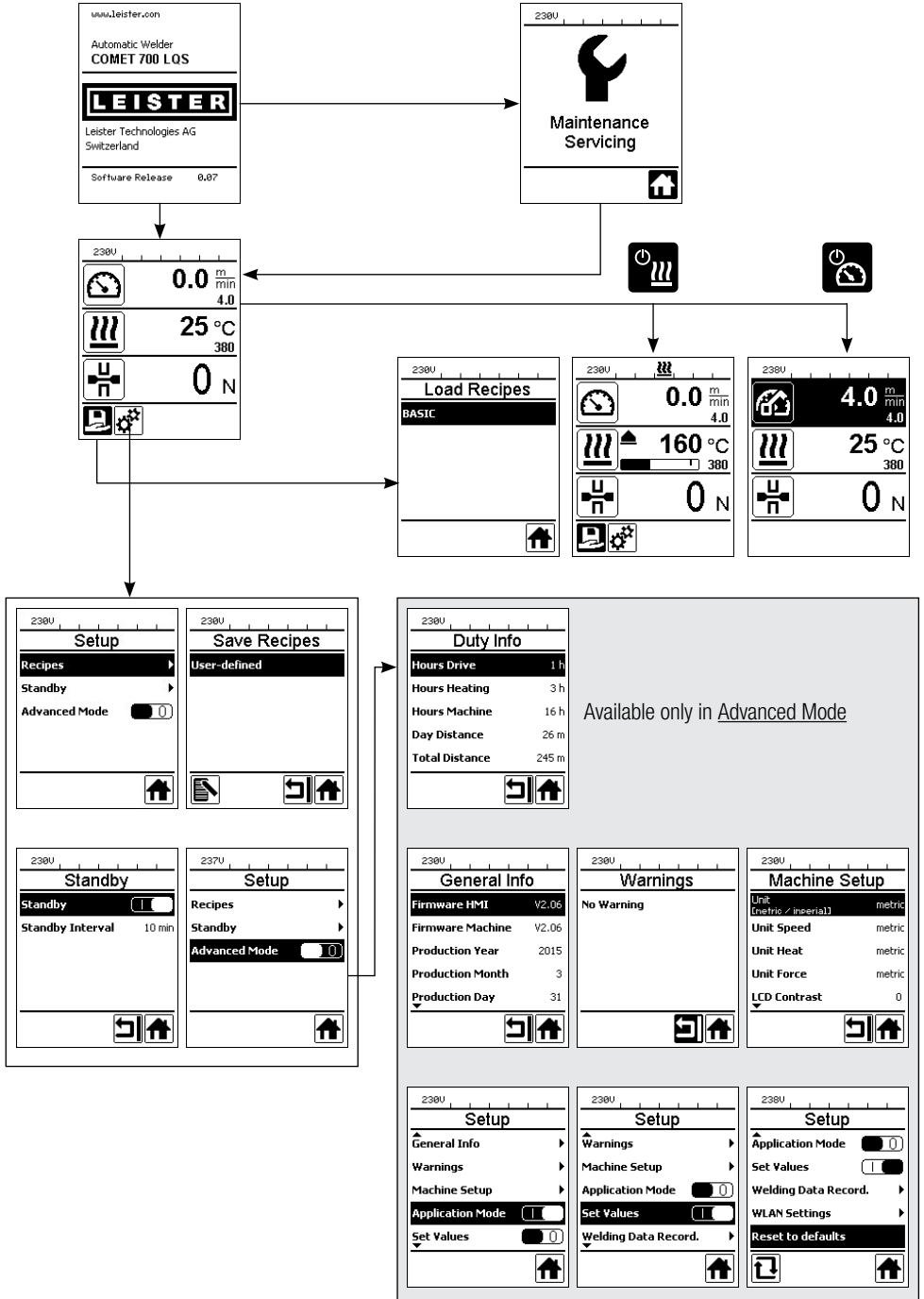

8.1. Menu navigation overview



8.2. Setting up, saving, and selecting recipes (Save recipes)

Your COMET 700 has more than 9 freely definable recipes and the **BASIC** recipe available. Save Recipes saves the currently set target values of the drive and hot-wedge temperature welding parameters under a user-definable name (max. 12 characters), see  Entering recipe names [8.3].

Creating a new recipe

1. Setting up the desired setpoints [**Working display (29)**, *e-drive (27)*].
2. Select and confirm symbol  **Settings** [**Function display (28)**, *e-drive (27)*]
3. Select and confirm menu **Recipes** [Menu selection, *e-drive (27)*]
4. Select and confirm menu **User-defined** [Menu selection, *e-drive (27)*]
5. Select and confirm symbol  **Edit** [**Function display (28)**, *e-drive (27)*]
6. Enter desired recipe name, see  Enter recipe name [8.3]
7. Select **Enter key**, see  Enter recipe name [8.3]
8. Select and confirm  Save symbol [**Function display (28)**, *e-drive*].

Your newly created recipe is now saved and can be accessed at any time under the name that has been input.

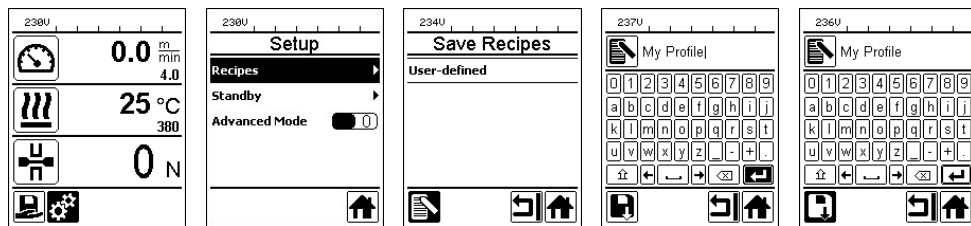

Load existing recipe

1. Select and confirm the symbol  Open recipe [**Function display (28)**, *e-drive (27)*].
 2. Use the **Up** and **Down keys (22/23)** or the *e-drive (27)* to set the cursor to the desired recipe and confirm with the *e-drive (27)*.
- If you change setpoints in user-defined recipes during operation, they are not saved. When the device is restarted, the values saved in the recipe will be displayed again.
 - If you wish to apply the most recently used setpoints when you restart the device, you have to select the preprogrammed **BASIC** recipe.
 - The currently selected recipe is selected in the **Status display area 1 (30)**. The **BASIC** recipe is an exception. If **BASIC** is selected, only the mains voltage appears in the **Status display (30)**.

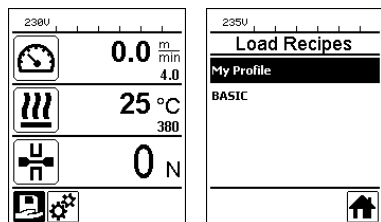

Overwrite existing recipe

1. Set up new target values [**Working display (29)**, *e-drive (27)*], heating and drive do not have to be switched on
2. Select and confirm symbol Settings [**Function display (28)**, *e-drive (27)*]
3. Select and confirm menu Recipes [Menu selection, *e-drive (27)*]
4. Select and confirm recipe to be overwritten [Menu selection, *e-drive (27)*]
5. Select and confirm symbol Save [**Function display (28)**, *e-drive (27)*]

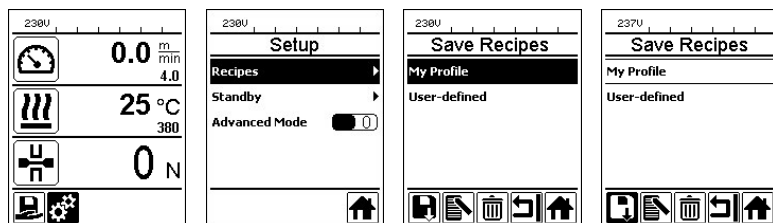

Rename existing recipe

1. Select and confirm symbol Settings [**Function display (28)**, *e-drive (27)*]
2. Select and confirm menu Recipes [Menu selection, *e-drive (27)*]
3. Select and confirm recipe to be renamed [Menu selection, *e-drive (27)*]
4. Select and confirm Edit symbol [**Function display (28)**, *e-drive (27)*]
5. Enter new recipe name (see Entry of recipe name [8.3])
6. Select Enter key (see Entry of recipe name [8.3])
7. Select and confirm symbol Save [**Function display (28)**, *e-drive (27)*]

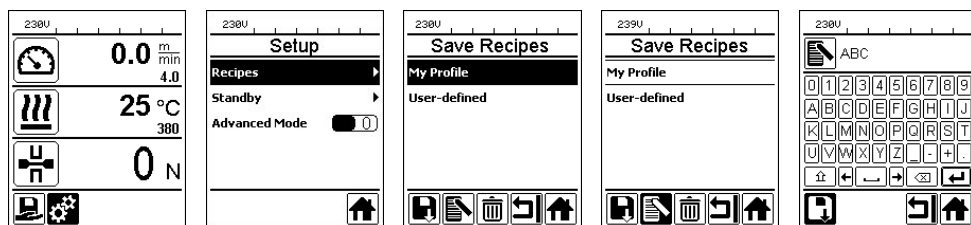

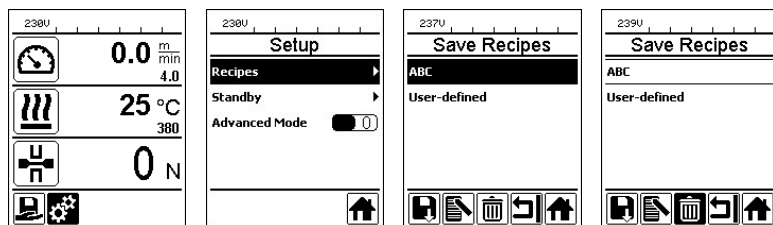

Delete existing recipe

1. Select and confirm symbol Settings [**Function display (28)**, *e-drive (27)*]
2. Select and confirm menu Recipes [Menu selection, *e-drive (27)*]
3. Select and confirm recipe to be overwritten [Menu selection, *e-drive (27)*]
4. Select and confirm symbol Delete [**Function display (28)**, *e-drive (27)*]





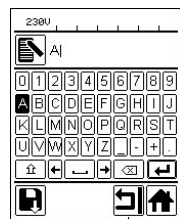

8.3. Entry of recipe names

Names must be defined with a max. 12 characters.

Key		Character selection (32)	Symbol selection (33)
	<i>Up (22)</i> <i>Down (23)</i>	Vertical character selection	
	Rotate <i>e-drive (27)</i>	Horizontal character selection	Horizontal symbol selection
	Press <i>e-drive (27)</i>	Confirm the selected characters	Confirm the selected symbols



28

	Change between upper and lower case
	Move the cursor position in the name
	Insert a blank space
	Delete one character (the character to the left of the cursor)
	Select this symbol to switch to the Function display (28)

8.4. Standby Mode

Standby mode is deactivated on delivery from the factory.

Enable standby mode

1. Select and confirm symbol **Settings** [function display (28), *e-drive (27)*]
2. Select and confirm menu **Standby** [Menu selection, *e-drive (27)*]
3. **Confirm Standby**, turn *e-drive (27)* clockwise (**Standby I**) and confirm [Menu selection, *e-drive (27)*]
4. **Select and confirm Standby Interval**, set and confirm the desired time interval [Menu selection, *e-drive (27)*]

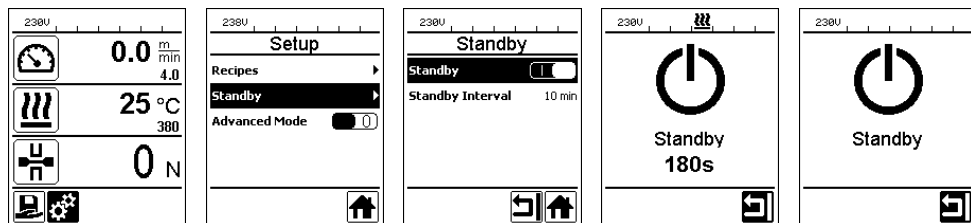

If the engine is switched off, the heating activated and if no key is activated during the time defined under **Standby Interval**, then the device will switch over automatically into Standby display. **Standby 180s** appears in the **working display (29)**. If the *e-drive (27)* is not pressed during the subsequent 180 seconds, then the heating will shut off automatically. **Standby** appears on the **working display (29)** at the same time. If the *e-drive (27)* is pressed during standby mode, the device switches to working mode. The heater must be switched on again manually.

Disable standby mode

1. Select and confirm symbol **Settings** [Function display (28), *e-drive (27)*]
2. Select and confirm menu **Standby** menu [Menu selection, *e-drive (27)*]
3. Confirm **standby**, turn *e-drive (27)* counterclockwise (**Standby 0**) and confirm [Menu selection, *e-drive (27)*]

8.5. Advanced Mode

The extended functions are deactivated at the factory.

Enable advanced features

1. Select and confirm symbol **Settings** [Function display (28), *e-drive (27)*]
2. Select and confirm **Advanced Mode** [Menu selection, *e-drive (27)*]
3. Turn *e-drive (27)* clockwise (**Advanced Mode I**) and confirm [Menu selection, *e-drive (27)*]

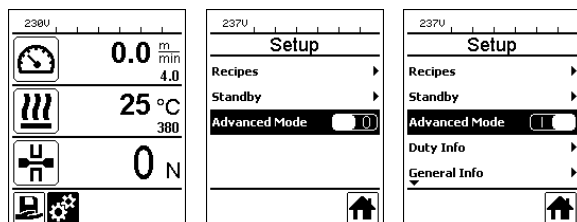

Additional information and setting options are available in **Advanced Mode** (see Menu navigation overview [8.1] and the following chapters).

Disable advanced features

1. Select and confirm symbol [Settings](#) [**Function display (28)**, *e-drive (27)*]
2. Select and confirm [Advanced Mode](#) [Menu selection, *e-drive (27)*]
3. Turn *e-drive (27)* clockwise ([Advanced Mode 0](#)) and confirm [Menu selection, *e-drive (27)*]

8.6. Duty Info

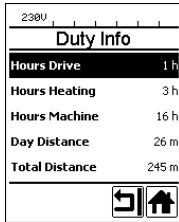

230V	
Duty Info	
Hours Drive	1 h
Hours Heating	3 h
Hours Machine	16 h
Day Distance	26 m
Total Distance	245 m
[Back] [Home]	

Only available with advanced functions [Advanced Mode](#).

Under [Duty Info](#) you will find information regarding the runtime of your COMET 700.

[Hours Drive](#): current running time of the drive

[Hours Heating](#): current running time of the heating

[Hours Machine](#): current running time of the machine

[Day Distance](#): distance traveled since last reset (must be reset manually)

[Total Distance](#): distance traveled since the device was put into operation

8.7. General Info

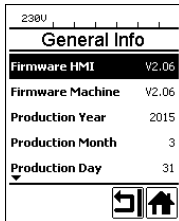

230V	
General Info	
Firmware HMI	V2.06
Firmware Machine	V2.06
Production Year	2015
Production Month	3
Production Day	31
[Back] [Home]	

Only available with advanced functions [Advanced Mode](#).

Under [General Info](#) you will find version information regarding the software in addition to information regarding the date of production.

8.8. Warnings

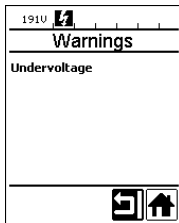

191V	
Warnings	
Undervoltage	
[Back] [Home]	

Only available with advanced functions [Advanced Mode](#).

Warnings are displayed on a case-by-case basis in the **status display (31)**. If there is a warning pending, you can still continue to work largely without restrictions. The menu [Warnings](#) indicates the type of malfunction.

Once the malfunction has been rectified, the entry disappears.

8.9. Machine Setup



230V	
Machine Setup	
Unit	Metric / Imperial
Unit Speed	metric
Unit Heat	metric
Unit Force	metric
LCD Contrast	0
[Back] [Home]	

Only available with advanced functions [Advanced Mode](#).

The unit system of the machine as well as the lighting of the **control panel (3)** can be set here.

[Unit](#): Uniform setting of the unit system (metric/imperial) for drive speed, hot-wedge temperature and joining force

[Unit Speed](#): individual setting of the unit used (metric/imperial) for drive speed

[Unit Heat](#): individual setting of the unit used (metric/imperial) for hot-wedge temperature

[Unit Force](#): individual setting of the unit used (metric/imperial) for joining force

[LCD Contrast](#): Adjust the contrast of the display

[LCD backlight](#): Adjust the backlight of the display

[Key Backlight](#): Adjusting the background illumination keyboard on the **Control panel (3)**

8.10. Application Mode

Only available with advanced functions [Advanced Mode](#).

Application [Mode](#) provides an overview of relevant information such as mains voltage, utilization of heating, etc.

Enable display of current values

1. Activate [advanced functions](#) [see  [Advanced functions \(Advanced Mode\)](#) [8.5]]
2. Select and confirm [Application mode](#) [Menu selection, [e-drive \(27\)](#)]
3. Turn [e-drive \(27\)](#) clockwise ([Application Mode I](#)) and confirm [Menu selection, [e-drive \(27\)](#)]

All available information is now displayed in the **working display (29)** below the joining force parameter.

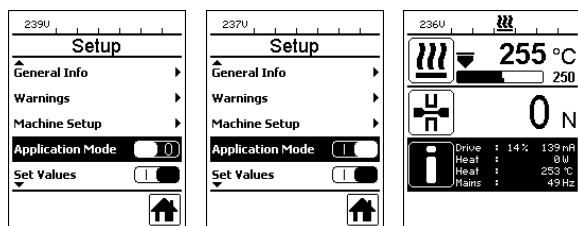

Enable display of current values

1. Activate [Advanced functions](#) [see  [Advanced functions \(Advanced Mode\)](#) [8.5]]
2. Select and confirm [Application mode](#) [Menu selection, [e-drive \(27\)](#)]
3. Turn [e-drive \(27\)](#) counterclockwise ([Application Mode 0](#)) and confirm [Menu selection, [e-drive \(27\)](#)]

8.11. Set Values

Only available with advanced functions [Advanced Mode](#).

The actual value display is activated at the factory.

When the actual value display is activated, the actual value (large) and the nominal value (small) are shown in the **working display (29)**. When the actual value display is deactivated, only the nominal value is displayed. This applies to the hot-wedge temperature and the drive speed. Only the actual value is displayed for the joining force.

Disable actual value display

1. Activate [Advanced functions](#) [see  [Advanced functions \(Advanced Mode\)](#) [8.5]]
2. Select and confirm [Set Values](#) [Menu selection, [e-drive \(27\)](#)]
3. Turn [e-drive \(27\)](#) counterclockwise ([Set Values 0](#)) and confirm [Menu selection, [e-drive \(27\)](#)]

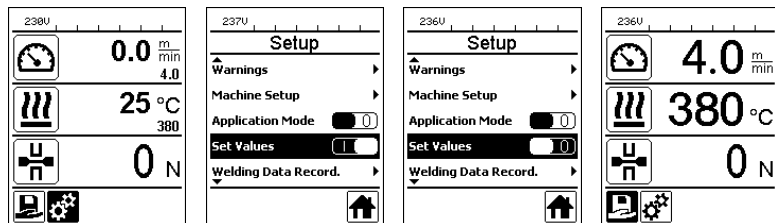

Reactivate the actual value display

1. Activate [Advanced functions](#) [see  [Advanced functions \(Advanced Mode\)](#) [8.5]]
2. Select and confirm [Set Values](#) [Menu selection, [e-drive \(27\)](#)]
3. Turn [e-drive \(27\)](#) clockwise ([Set Values I](#)) and confirm [Menu selection, [e-drive \(27\)](#)]

8.12. Welding data recording and WLAN settings WLAN settings

Only available with advanced functions [Advanced Mode](#).

Your COMET 700 has the Leister Quality System (LQS) and thus the function of welding data recording. Using the LQS and myLeister app, the COMET 700 records the drive speed, the hot-wedge temperature and the joining force during welding over the welding seam length at the specified distance interval. You can find more information in the corresponding operating instructions LQS/myLeister at www.leister.com.

8.13. Reset (Reset to defaults)

Only available with advanced functions [Advanced Mode](#).

This function can be used to reset all of the individually set values back to the factory settings.

Caution: Resetting will affect both your settings and the deletion of your recipes.

1. Activate and confirm [Advanced functions](#) [see  Advanced functions (Advanced Mode) [8.5]]
2. Select and confirm [Reset to defaults](#) [Menu selection, *e-drive* (27)]
3. Select and confirm symbol [Reset](#) [Function display (28), *e-drive* (27)]

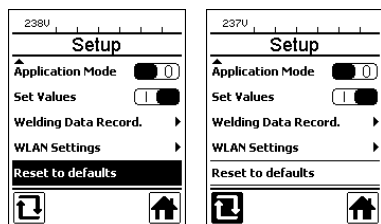

8.14. Day distance display

As soon as the drive is switched on and more than 100N force is displayed in the **working display (29)**, the recording of the welded distance begins. You can call up the day distance as follows:

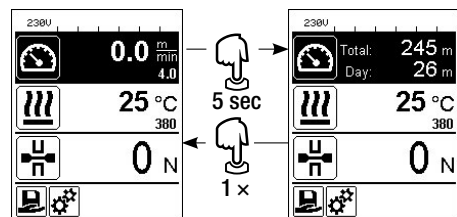

- Use the *Up* (22) and *Down* (23) arrow keys to position the cursor on the speed in the **working display (29)**.
- Hold the *e-drive* (27) down for 5 seconds.
- The values of the day distance and the total distance are now shown in the drive speed display.
- Briefly pressing the *e-drive* (27) causes the speed to be shown again in the **working display (29)**.

In welding operation

- The drive speed is blocked during welding.
- Pressing the *e-drive* (27) briefly unlocks the drive speed.
- Hold the *e-drive* (27) down for 5 seconds.
- The values of the day distance and the total distance are now shown in the speed display.
- Briefly pressing the *e-drive* (27) causes the speed to be shown again in the **working display (29)**.
- After leaving the day distance display, the drive speed is blocked again.

Resetting the day distance

The day distance can be reset only once the drive is switched off.





1. Under Duty Info (see  Operating time (Duty Info) [8.6]), select the Day Distance line and confirm with *e-drive* (27).
2. Select and confirm the Reset symbol [**Function display (28)**, *e-drive* (27)].
3. The day distance is now reset.

230U	
Duty Info	
Hours Drive	1 h
Hours Heating	3 h
Hours Machine	17 h
Day Distance	26 m
Total Distance	245 m

230U	
Duty Info	
Hours Drive	1 h
Hours Heating	3 h
Hours Machine	17 h
Day Distance	26 m
Total Distance	245 m

8.15. Key lock

The COMET 700 has a key lock. This locks the four *keys* (22 to 25) and the *e-drive* (27) on the **control panel (3)**. The key lock is activated or deactivated by simultaneously pressing the *Up* and *Down* keys (22/23) for at least 2 seconds. When the key lock is activated, this is shown in the **status bar area 2 (31)**.

230U	
	0.0 ^m / _{min} 4.0
	25 °C 380
	0 N
	

9. Commissioning COMET 700

9.1. Work environment and safety



Risk of fire and explosion

The welding machine can become an ignition source for fire and explosion. It must therefore not be used near explosive gases or flammable materials. To avoid burning of the material to be welded, please read the material safety data sheet from the material manufacturer. The welding machine must only be used in the open or in a well-ventilated area.



Risk

of poisoning in case of overheating of PVC, toxic hydrogen chloride vapors develop. Therefore, good ventilation must always be ensured when working. In addition, when processing PVC, the specifications of the material manufacturers must always be observed.

Power cord and extension cable



The power cord (1) and extension cable must be able to move freely and must not hinder the user or third parties during work (trip hazard).



The extension cables must be authorized for the utilization site (such as, outdoors) and be marked accordingly. The minimum cross-section for extension cables must be observed (depending on the required length and the current load). Extension cables should be as short as possible and must always be unwound when used. Make sure that all extension cables comply with local codes and regulations. Suitable connector plugs must be used that are clean and corrosion-free.

230 V~	up to 50 m	3 × 1.5 mm²	120 V~	up to 50 m	3 × 1.5 mm²
	up to 100 m	3 × 2.5 mm²		up to 100 m	3 × 2.5 mm²



Use on mobile power generators

The following formula applies to the power rating of mobile power generators:

Power generator rating = at least 2× power rating of all devices used.

If you are using a mobile power generator, it should have a total distortion fraction of the sine waveform (THD=Total Harmonic Distortion) of less than 6%. This information can be found in the technical data or can be obtained from the supplier.

When using mobile power generators with a THD value greater than 6%, damage to electronic components may occur. Leister therefore recommends using portable power generators with inverter technology.

The hot wedge welding machine may only be switched on and off when the generator is running, otherwise the electronic components may be damaged.

9.2. Preparation for welding



Connect the device to an outlet with a **protective conductor. Any interruption of the protective conductor inside or outside of the device is not permitted.** Only use extension cables with protective conductors.



The local supply voltage must match the **nominal voltage** specified on the device. If the line voltage fails, switch off the main switch and place the welding machine in the park position. EN 61000-3-11; $Z_{max} = 0.324\Omega + j 0.202\Omega$. Consult electricity supply company if necessary.



If the device is being used on construction sites, a **fault current circuit breaker** must be used to protect site personnel from electrical shock **due to dampness and moisture.**

Starting the device

- Switch on the hot wedge welding machine via the **main switch (17)** once you have prepared the working environment and set the hot wedge welding machine according to the description (see  Settings on the COMET 700/500 [5]).
- After startup, the Start screen will appear briefly in the display with the device designation and the version number of the current firmware release and the device designation.
- This is followed by the display of the setpoints of the last recipe used (the BASIC recipe is displayed when the device is first commissioned).



Risk of crushing and shearing

When operating the clamping lever and clamping arm, there is a risk of injury to the hand. Always hold the hot wedge welding machine by the handles and control units provided.



Exceeding the maximum joining force of 1000N can cause mechanical damage to the device.

Adjusting the joining force

- Unlock the **clamping lever lock (5)** and open the **clamping lever (4)**.
- Unlock the adjustment ring lock (34) on the **joining force module (6)** and turn the **adjustment ring (35)** counterclockwise until the maximum opening of the **clamping arm (7)**.
- Place two **test strips (36)** of the material to be welded on top of each other between the **upper and lower drive/pressure rollers (9/11)** and close the **clamping lever (4)**.
- Turn the **adjustment ring (35)** of the **joining force module (6)** clockwise until the **upper and lower drive/pressure rollers (9/11)** slightly clamp the **test strips (36)**.
- Unlock the **clamping lever lock (5)** and open the **clamping lever (4)**.
- Rotate the **adjustment ring (35)** clockwise while the **joining force module (6)** is open until the joining force shown on the **working display (29)** matches the desired joining force with the **clamping arm (4)** closed and the **test strips (36)** inserted. To do this, the **clamping lever (4)** must be opened and closed repeatedly.
- Lock the **adjustment ring lock (34)** on the **joining force module (6)**, so that the joining force cannot be adjusted unintentionally.

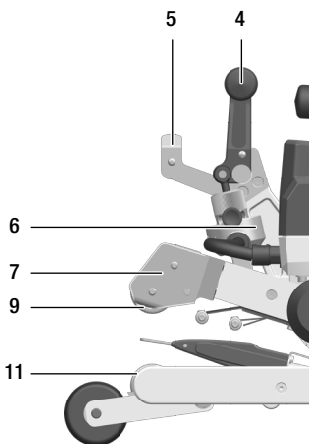

Clamping lever (4) open

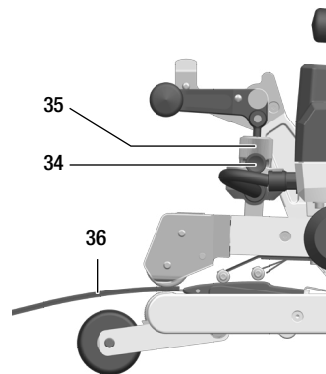

Clamping lever (4) closed

Setting the welding parameters for the drive speed and hot-wedge temperature before welding

If the drive is switched off, the working temperature and drive speed welding parameters in the **working display (29)** are set as follows:

- Using the *Up (22)* and *Down (23)* arrow keys, you can set the cursor to the desired **working display (29)**.
- Rotate the *e-drive (27)* to the setpoint. The set value is applied immediately.
- A switch is made to the **function display (28)** by pressing *e-drive (27)*. If no key is pressed within 5 seconds, this happens automatically.

9.3. Welding process

Notes

For satisfactory welding quality, the following instructions must be observed.

- Before the automatic welder is used, test welds are to be carried out in accordance with the welding instructions of the material manufacturer and with national standards or guidelines. The test welds must be checked.
- The maximum overlap width of the lower and upper membranes is 125 mm.
- The sealing sheets must be clean and dry between the overlaps and on the upper and lower side.
- Welding is not permitted in case of precipitation or through puddles.

Start welding



Do not touch moving parts

There is a risk of inadvertently becoming caught and being pulled in. Do not wear loose articles of clothing such as scarves or shawls. Tie up long hair or protect it by wearing headgear.



Risk of burns

Do not touch hot wedge and surrounding parts when hot. Only touch the device at the handles and operating units and always let it cool down.

- Once you have set all welding parameters in line with your requirements, start the heating. The *Heating on/off (24)* key must be held down for 2 seconds.
- As soon as the heating is switched on, an acoustic signal sounds. The **status LED (26)** on the *Heating On/Off (24)* key (lights up and the **working display (29)** briefly shows Heating on.
- If the actual value display (see Actual value display (Set values) [8.11]) is activated, a dynamic display of the current hot-wedge temperature is displayed.
- Make sure that the hot-wedge temperature has been reached before commencing work. The heat-up time is 2 to 3 minutes.
- Insert the hot wedge welding machine into the overlapping plastic sheets.
- Start the drive using the *Drive on/off (25)* key.
- Close the **clamping lever (4)**, so that the **clamping lever lock (5)** engages.
- If you have activated the welding data recording (see Welding data recording (Welding Data record.) and WLAN setting (WLAN Settings) [8.12]), the document number of the current weld is shown in the **status display area 1 (30)** alternating with the mains voltage display.
- During the welding process, the hot wedge welding machine can be guided along the overlap using the **handles (2)** or the optional guide bar.

Setting the welding parameters for the drive speed and hot-wedge temperature before welding

If the drive is switched off, the working temperature and drive speed welding parameters in the **working display (29)** are set as follows:

- During welding, the drive speed is locked and the cursor is positioned in the drive speed field.
- Press the *e-drive (27)* briefly to unlock the drive speed and turn the *e-drive (27)* to change the target speed.
- After 5 sec. or by pressing the *e-drive (27)*, the drive speed is blocked again.
- Using the *Up (22)* and *Down (23)* arrow keys, you can set the cursor to the heating working display. Turn the *e-drive (27)* to adjust the target temperature.



Drive speed locked



Drive speed unlocked

Finishing welding

- Unlock the **clamping lever lock (5)** and open the **clamping lever (4)** shortly before the end of the welding seam. The **upper drive/pressure roller (9)** and the **lower drive/pressure roller (11)** must never run directly on one another.
- Switch the drive and heating off using the *Drive on/off (25)* and *Heating on/off (24)* keys. The *Heating on/off (24)* key must be held down for 2 seconds.
- The Heating off display appears on the **working display (29)**.
- Switch off the device with the **main switch (17)** and disconnect the **power cord (1)** from the electrical mains.





- Wait until the device has cooled down.
- Check the **power cord (1)** and plug for electrical and/or mechanical damage.
- Clean the **hot wedge (15)** and the **drive/pressure rollers (9/11)** as well as the **contacting system (13/14)** with the brass brush.

10. Warnings and error messages COMET 700

Warning and error messages are shown in the **Status display area 2 (31)** or in the **working display (29)**.

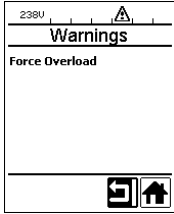
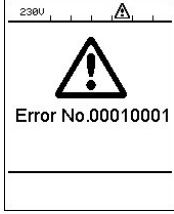
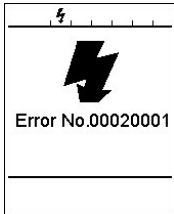
- If there is a warning, you can continue to work without restriction, even though you should find and correct the cause of the warning.
- Specific information about the type of warning can be accessed at any time via the Settings menu under Warning display (see  Warning display (Warnings) [8.8]).
- If an error message appears, you cannot continue working. The heating and the drive are switched off automatically. The corresponding error code is immediately displayed in the **working display (29)**.

Message type	Display	Error code/ Warning message	Error description
Warnings		Overtemp. Ambient	Ambient temperature of electronics is too high
		Overtemp. Amb.: HMI	Operating unit ambient temperature is too high
		Undervoltage	Undervoltage present
		Overvoltage	Overvoltage present
		Force overload	max. Joining force (1000N) exceeded
		Drive overload	Drive current limiting is active
Error (Error)		Group 0001'XXXX e.g. 00010001	Temperature problems with the electronic components solution: Allow the device to cool down.
		Group 0002'XXXX e.g. 00020001	Voltage problems solution: Check voltage source
		Group 0004'XXXX e.g. 00040002	Hardware Issues ¹
		Group 0008'XXXX e.g. 00080001	Temperature Sensor Issues ¹
		Group 0200'XXXX e.g. 02000001	Communication Module Issues ¹
Group 0400'XXXX e.g. 04000001		Drive Issues ¹	

¹ Take a photo of the error message and contact your Leister Service Center.

11. COMET 500 control panel

11.1. Control panel overview

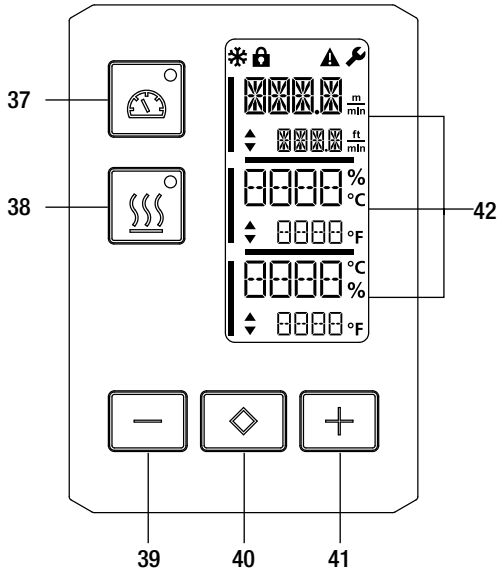

- 37. Drive on/off key with status LED
- 38. Heating on/off key with status LED
- 39. Minus key
- 40. Confirm key
- 41. Plus key
- 42. Display fields

The actual values are displayed in large font and the setpoint values in small font. The cursor is located on the left-hand side and the parameter unit on the right-hand side.

11.2. Status LED display

Drive

The **status LED** of the key *Drive on/off (37)* shows the respective state of the drive.

Status LED for the <i>Drive on/off (37)</i> key	Condition
LED off	Drive is switched off
LED continuously green	Drive is switched on

The status LED





of the key *Heating on/off (38)* shows the respective heating state.

Status LED for the <i>Heating on/off (38)</i> key	Condition
LED off	Heating is switched off.
LED flashes green	Heating is switched on, hot wedge temperature outside the tolerance range
LED continuously green	Heating is switched on, hot wedge temperature within the tolerance range

Drive and heating

If both LEDs of the *Drive on/off (37)* and *Heating on/off (38)* key flash simultaneously, there is an error (see error messages COMET 500 [13]).

11.3. Display symbols

Symbol	Meaning
	Key lock active
	Cool Down Mode Symbol for cooling
	Error present see  error messages COMET 500 [13]
	Service required

11.4. Setting the unit system

The units for the hot wedge temperature and drive speed can be adjusted.

Temperature: °C or °F

Speed: $\frac{\text{m}}{\text{min}}$ or $\frac{\text{ft}}{\text{min}}$

- Hold down the *Drive on/off* (37) and *Heating on/off* (38) simultaneously and switch on the device using the **main switch** (17). **UNIT** then appears on the display.
- Confirm with the *Confirm* (40) key.
- Use the *Minus* (39) and *Plus* (41) keys to set the desired unit system.
- Confirm with the *Confirm* (40) key.
- Use the *Plus* (41) key to select **SAVE**.
- Confirm with the *Confirm* (40) key.
- The units are now saved, the start screen appears.

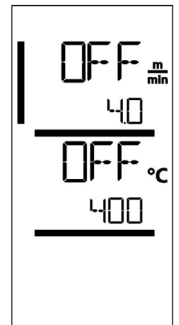
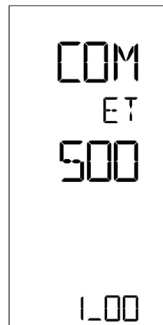
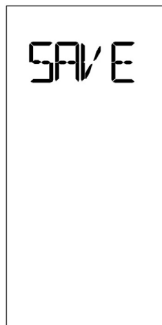
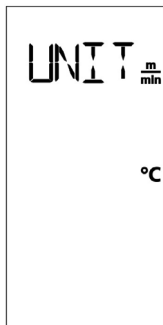
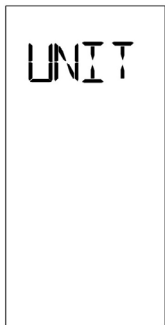

11.5. Key lock

The COMET 500 has a key lock. It blocks the 5 keys on the control panel. The key lock is activated or deactivated by simultaneously pressing the *Minus* (39) and *Plus* (41) keys for at least 3 seconds. When the key lock is active, this is displayed in the **display field** (42) (see  Display of the status LED [11.2]).

12. Commissioning COMET 500

12.1. Work environment and safety



Risk of fire and explosion

The welding machine can become an ignition source for fire and explosion. It must therefore not be used near explosive gases or flammable materials. To avoid burning of the material to be welded, please read the material safety data sheet from the material manufacturer. The welding machine must only be used in the open or in a well-ventilated area.



Risk

of poisoning in case of overheating of PVC, toxic hydrogen chloride vapors develop. Therefore, good ventilation must always be ensured when working. In addition, when processing PVC, the specifications of the material manufacturers must always be observed.

Power cord and extension cable



The power cord (1) and extension cable must be able to move freely and must not hinder the user or third parties during work (trip hazard).



The extension cables must be authorized for the utilization site (such as, outdoors) and be marked accordingly. The minimum cross-section for extension cables must be observed (depending on the required length and the current load). Extension cables should be as short as possible and must always be unwound when used. Make sure that all extension cables comply with local codes and regulations. Suitable connector plugs must be used that are clean and corrosion-free.

230 V~	up to	50 m	3 × 1.5 mm²	120 V~	up to	50 m	3 × 1.5 mm²
	up to	100 m	3 × 2.5 mm²		up to	100 m	3 × 2.5 mm²



Use on mobile power generators

The following formula applies to the power rating of mobile power generators:

Power generator rating = at least 2× power rating of all devices used.

If you are using a mobile power generator, it should have a total distortion fraction of the sine waveform (THD=Total Harmonic Distortion) of less than 6%. This information can be found in the technical data or can be obtained from the supplier.

When using mobile power generators with a THD value greater than 6%, damage to electronic components may occur. Leister therefore recommends using portable power generators with inverter technology.

The hot wedge welding machine may only be switched on and off when the generator is running, otherwise the electronic components may be damaged.

12.2. Preparation for welding



Connect the device to an outlet with a **protective conductor**. Any interruption of the protective conductor inside or outside of the device is not permitted. Only use extension cables with protective conductors.





The local supply voltage must match the **nominal voltage** specified on the device. If the line voltage fails, switch off the main switch and place the welding machine in the park position. EN 61000-3-11; $Z_{\text{max}} = 0.324\Omega + j 0.202\Omega$. Consult electricity supply company if necessary.

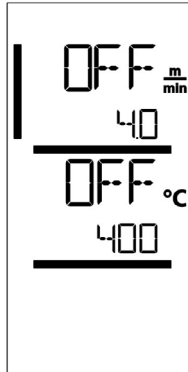
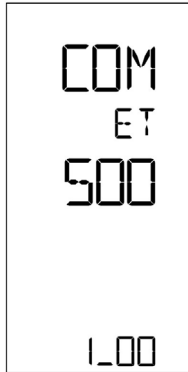

If the device is being used on construction sites, a **fault current circuit breaker** must be used to protect site personnel from electrical shock **due to dampness and moisture**.

Starting the device



- Switch on the hot wedge welding machine via the **main switch (17)** once you have prepared the working environment and set the hot wedge welding machine according to the description (see  Settings on the COMET 700/500 [5]).
- After startup, the Start screen will appear briefly in the display with the device designation and the version number of the current firmware release and the device designation.
- This is followed by the display of the last setpoint values set.



Risk of crushing and shearing

When operating the clamping lever and clamping arm, there is a risk of injury to the hand. Always hold the hot wedge welding machine by the handles and control units provided.

Adjusting the joining force

The **joining force module (6)** on the COMET 500 prevents the setting of excessive joining force when welding material thicknesses of up to 3 mm. A smaller joining force is applied for thinner materials and a greater joining force for thicker materials. The welding force can be increased or decreased slightly by rotating the **adjustment ring (35)**. The setting range is approx. 360°. Proceed as follows to adjust the joining force:

- Unlock the **clamping lever lock (5)** and open the **clamping lever (4)**.
- Unlock the adjustment ring **lock (34)** on the **joining force module (6)**.
- Rotate the **adjustment ring (35)** on the **joining force module (6)**. Rotating it in the "+" direction increases the joining force and rotating it in the "-" direction decreases it. The **adjustment ring (35)** can be rotated by approx. 360° from the minimum to maximum position.
- Once the desired joining force has been set, lock the **adjustment ring lock (34)** again.
- If you do not know the best joining force, set the **adjustment ring (35)** to the middle position. After a test weld, you can increase or decrease the joining force, if necessary.

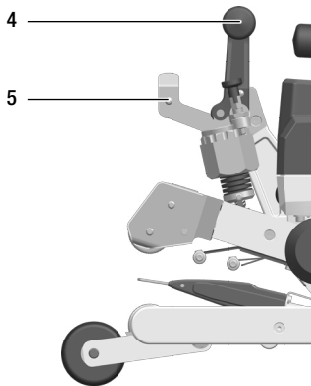

Clamping lever (4) open

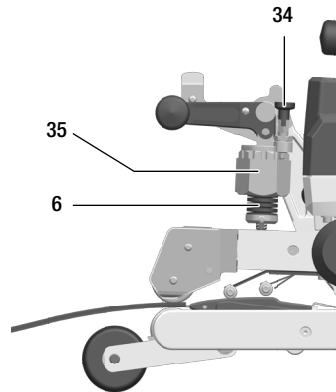

Clamping lever (4) closed

Setting the welding parameters for the drive speed and hot-wedge temperature before welding

- If the drive is switched off, the hot wedge temperature and drive speed welding parameters in the **display fields (42)** are set as follows:
- Using the *Confirm (40)* key, you can set the cursor to the desired parameter.
- Use the *Plus (41)* and *Minus (39)* keys to set the values of the selected parameter.

12.3. Welding process

Notes

For satisfactory welding quality, the following instructions must be observed.

- Before the automatic welder is used, test welds are to be carried out in accordance with the welding instructions of the material manufacturer and with national standards or guidelines. The test welds must be checked.
- The maximum overlap width of the lower and upper membranes is 125 mm.
- The sealing sheets must be clean and dry between the overlaps and on the upper and lower side.
- Welding is not permitted in case of precipitation or through puddles.

Start welding



Do not touch moving parts

There is a risk of inadvertently becoming caught and being pulled in. Do not wear loose articles of clothing such as scarves or shawls. Tie up long hair or protect it by wearing headgear.



Risk of burns

Do not touch hot wedge and surrounding parts when hot. Only touch the device at the handles and operating units and always let it cool down.

- Once you have set all welding parameters in line with your requirements, start the heating. The *Heating on/off (38)* key must be held down for 2 seconds.
- As soon as the heating switches on, the **status LED** of the *Heating On/Off (38)* key lights up. An arrow pointing upwards appears next to the setpoint value of the hot-wedge temperature in the **display fields (42)**. The hot-wedge temperature increases.
- Make sure that the hot-wedge temperature has been reached before commencing work. The heat-up time is 2 to 3 minutes.
- Insert the hot wedge welding machine into the overlapping plastic sheets.
- Start the drive using the *Drive on/off (37)* key.
- Close the **clamping lever (4)**, so that the **clamping lever lock (5)** engages.
- During the welding process, the hot wedge welding machine can be guided along the overlap using the **handles (2)** or the optional guide bar.

Setting the welding parameters for the drive speed and hot-wedge temperature before welding

If the drive is switched on, then the welding parameters in the **working display (42)** are set as follows:

- The drive speed and hot wedge temperature welding parameters can be changed at any time during welding (see  Setting the welding parameters [12.2]). The cursor switches automatically to the drive speed line 5 seconds after the last entry.

Finishing welding

- Unlock the **clamping lever lock (5)** and open the **clamping lever (4)** shortly before the end of the welding seam. The **upper drive/pressure roller (9)** and the **lower drive/pressure roller (11)** must never run directly on one another.
- Switch the drive and heating off using the *Drive on/off (37)* and *Heating on/off (38)* keys. The *Heating on/off (38)* key must be held down for 2 seconds.
- Switch off the device with the **main switch (17)** and disconnect the **power cord (1)** from the electrical mains.



- Wait until the device has cooled down.
- Check the **power cord (1)** and plug for electrical and/or mechanical damage.
- Clean the **hot wedge (15)** and the **drive/pressure rollers (9/11)** as well as the **contacting system (13/14)** with the brass brush.

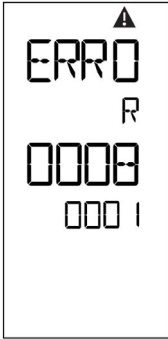

13. COMET 500 errors

Message type	Display	Error code	Error description
Error (Error)		Group 0001'XXXX e.g. 00010001	Temperature problems solution: Allow the device to cool down.
		Group 0004'XXXX e.g. 00040002	Hardware Issues ¹
		Group 0008'XXXX e.g. 00080001	Temperature Sensor Issues ¹
		Group 0200'XXXX e.g. 02000001	Communication Module Issues ¹
		Group 0400'XXXX e.g. 04000001	Drive Issues ¹

¹ Take a photo of the error message and contact your Leister Service Center.

14. Frequently asked questions, causes, and measures COMET 700/500

Deficient welding result quality:

- Check drive speed, hot wedge temperature and potentially joining force
- **Clean hot wedge (15), drive/pressure rollers (9/11) and contacting system (13/14)** with brass brush (see COMET 700/500  maintenance) [16].
- **Hot wedge (15)** incorrectly positioned
(see  Check position of the hot wedge [5.1])
- wrong contacting system used
(see Contacting system  setup [5.2])

15. Assembly of accessories COMET 700/500



The device must have cooled down and the main switch must have been switched off before components on the hot wedge welding machine are dismantled or assembled. The power cord must have been disconnected from the power supply.



Risk of crushing and shearing

When operating the clamping lever and clamping arm, there is a risk of injury to the hand. Always hold the hot wedge welding machine by the handles and control units provided.

15.1. Replacement of drive/pressure rollers

Depending on the application, you can use different **drive/pressure rollers (9/11)** for the COMET 700/500. Various rollers are available. Ask your distributor for further information.

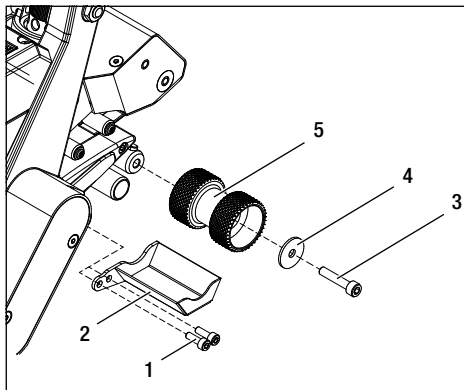

Assembling the bottom drive/pressure roller (11):
Sequence no. 1 – 5

Assembling the bottom drive/pressure roller (11):
Sequence no. 5 – 1

1. Cylinder screw (2x)
2. roller cover
3. cylinder screw
4. washer
5. drive/pressure roller

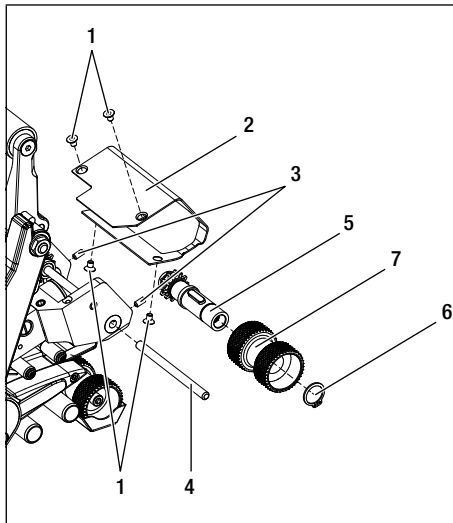

Assembling the top drive/pressure roller (9):
Sequence no. 1 – 7

Assembling the top drive/pressure roller (9):
Sequence no. 7 – 1

1. Countersunk screw (4x)
2. Protective plate, swivel head
3. Set screw (2x)
4. axis
5. drive shaft with key
6. locking ring
7. drive/pressure roller

15.2. Assembling the field kit

If a greater floor clearance or larger track rollers are required for the hot wedge welding machine, the indoor rollers can be replaced by the field kit. Depending on the configuration, you have already mounted the field kit.

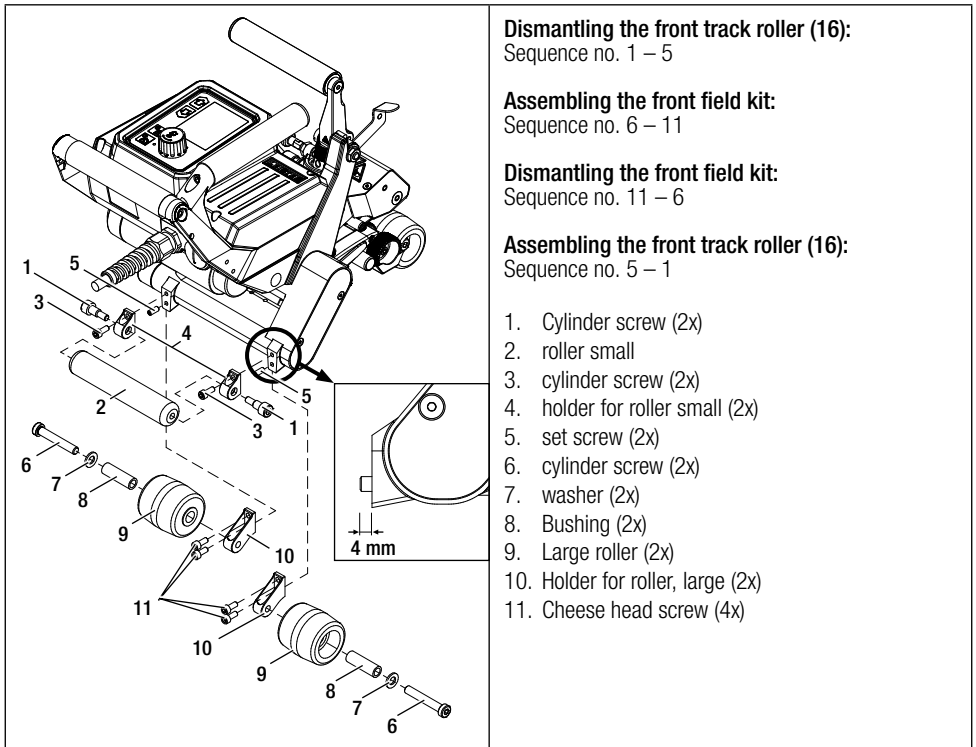
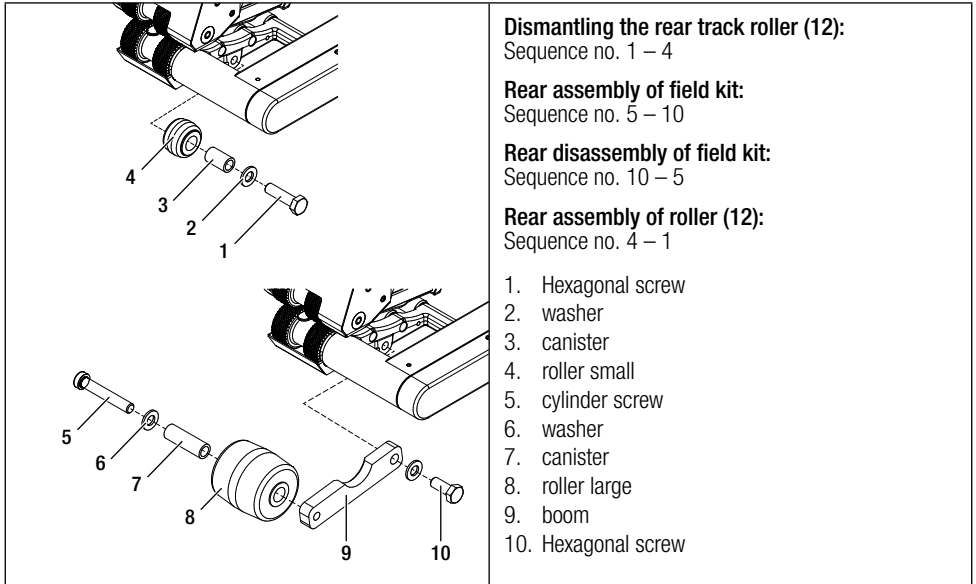

15.3. Assembling the guide bar

With the guide bar, you can guide the automatic welder in an upright position.

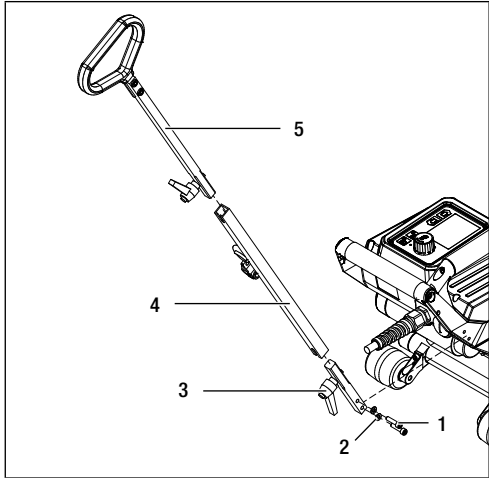

**Assembling guide bar
(optional accessories):**
Sequence no. 1 – 5

**Disassembling guide bar
(optional accessories):**
Sequence no. 5 – 1

1. Cylinder screw (2x)
2. washer (2x)
3. holder
4. connecting pipe
5. handle

15.4. Assembling the drive roller extension

With the drive roller extension, the membrane is supported laterally during the welding process. This prevents any kinks outside the welding zone.

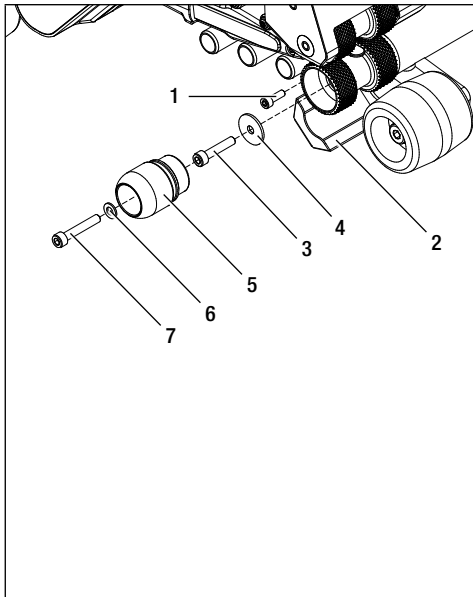

Assembling the roller cover:
Sequence no. 1 – 4

**Assembling the drive roller extension
(optional accessory):**
Sequence no. 1 – 5, 2, 1

**Disassembling the drive roller extension
(optional accessory):**
Sequence no. 1, 2, 7 – 5

Assembling the roller cover:
Sequence no. 4 – 1

1. Cylinder screw
2. roller cover (swivel)
3. cylinder screw
4. washer
5. drive roller extension
6. washer
7. cylinder screw

16. Maintenance COMET 700/500



The device must be cooled down and the main switch must be switched off for maintenance of the device. The power cord must have been disconnected from the power supply.



There may be a risk of injury from sharp edges due to possible material damage to the device due to corrosion or wear.



Risk of crushing and shearing

When operating the clamping lever and clamping arm, there is a risk of injury to the hand. Always hold the hot wedge welding machine by the handles and control units provided.

- Maintaining the service intervals allows you to achieve a longer service life of your appliance.
- If the maintenance intervals are not observed, reliable welding is not guaranteed.
- Repairs must only be carried out by authorized Leister service centers.
- Do not use any aggressive cleaning agents or solvents to clean the device.
- Leister service centers guarantee a professional and reliable repair service with original spare parts.
- You can find more information at www.leister.com.

Recommended maintenance intervals for the device:

Period of time (operating hours)	Monitoring and maintenance work	Spare parts	Tools
After each use of the device	Visual inspection, cleaning of hot wedge (15), drive/pressure rollers (9/11) and contact system (13/14)	–	Brass brush
Every 100 hours	Lubricate chains	–	Interflon Fin Grease
Every 1000 hours	Check the drive, contact your distributor	Engine or gear-box, chains	according to repair instructions

17. Disposal of COMET 700/500



Electrical equipment, accessories, and packaging should be recycled in an environmentally friendly way. When you are disposing of our products, please observe the national and local regulations. Do not dispose of electrical equipment with household refuse.

18. Declaration of conformity COMET 700/500

EU Declaration of Conformity

Leister Technologies AG, Galileo-Strasse 10, 6056 Kaegiswil, Switzerland confirms that this product fulfills the requirements of the following EU Directives in the models that we have made available for purchase.

Directives: 2006/42/EC, 2014/35/EU, 2014/53/EU, 2011/65/EU

Harmonized EN ISO 12100, EN 60204-1, EN 55014-1, EN 55014-2, EN 61000-3-2,

standards: EN 61000-3-3, EN 61000-6-2, EN 62233, EN 60335-1, EN 60335-2-45, EN IEC 63000, ETSI EN 300 328 V2.2.2

Kaegiswil, 12/09/2021

Bruno von Wyl, CTO

Christoph Baumgartner, GM

UK Declaration of Conformity

Leister Technologies AG, Galileo-Strasse 10, 6056 Kaegiswil, Switzerland confirms that these products, in the versions as brought into circulation through us, fulfil the requirements of the following UK Statutory Instruments.

UK Statutory

Instruments: 2008 No. 1597, 2017 No. 1206, 2012 No. 3032

Designated EN ISO 12100, EN 60204-1, EN 55014-1, EN 55014-2, EN 61000-3-2,

Standards: EN 61000-3-3, EN 61000-6-2, EN 62233, EN 60335-1, EN 60335-2-45, EN IEC 63000, ETSI EN 300 328 V2.2.2

Kaegiswil, 12/09/2021

Bruno von Wyl, CTO

Christoph Baumgartner, GM



Warranty

- The guarantee or warranty rights granted for this device by the direct distribution partner/salesperson apply from the date of purchase.
- In the event of a guarantee or warranty claim (verification by invoice or delivery note), manufacturing or processing errors will be rectified by the sales partner through replacement delivery or repair.
- Other guarantee or warranty claims are excluded within the framework of mandatory law.
- Damage resulting from natural wear, overload, or improper handling is excluded from the warranty.
- Heating elements are excluded from warranty obligations or guarantees.
- Guarantee or warranty claims cannot be asserted for devices that have been converted or changed by the purchaser or for which non-original Leister spare parts have been used.

↳ Sales and service center

Leister Technologies AG
Galileo-Strasse 10
6056 Kaegiswil/Switzerland
Tel. +41 41 662 74 74
Fax +41 41 662 74 16
www.leister.com
sales@leister.com